

# CV2

CV2-32, CV2-40, CV2-50, CV2-63  
CV2-32 red, CV2-40 red, CV2-50 red, CV2-63 red  
Overvoltage protection for professionals

The voltage monitoring relay with a current control ZUBR CV2 (hereinafter referred to as the device) is designed to protect a single-phase electrical equipment from deviated voltage, current or full power. It allows to estimate the capacity factor in electric grids ( $\cos \phi$ ). In case of voltage deviations, ZUBR CV2 turns off the load, and in case of normalization it turns it back on. Equipment that is easily affected to line voltage deviations: refrigerators, TVs, video and audio equipment, computers, etc.

All settings are stored in non-volatile memory.

## IN THE BOX

Voltage relay with a current control	1 piece
Technical data sheet, installation and operation manual, warranty card	1 piece
The packing box	1 piece

## TECHNICAL DATA

Model	CV2-32 CV2-32 red	CV2-40 CV2-40 red	CV2-50 CV2-50 red	CV2-63 CV2-63 red
Rated load current (for category AC-1)	32 A (max 40 A 10 min)	40 A (max 50 A 10 min)	50 A (max 60 A 10 min)	63 A (max 80 A 10 min)
Rated power load (for category AC-1)	7 000 VA	8 800 VA	11 000 VA	13 900 VA
Main current limit	0,1–32 A	0,1–40 A	0,1–50 A	0,1–63 A
Power limits	0,1–7 kVA	0,1–8,8 kVA	0,1–11 kVA	0,1–13,9 kVA
The number of operating cycles under load, not less	100 000 cycles	10 000 cycles		
The number of operating cycles without load, not less	1000 000 cycles	500 000 cycles		
Relay type	electromagnetic		polarized	
Current measurement accuracy	0,5–63 A $\pm 0,1-0,3$ A			
Voltage limit	upper 220–280 V, lower 120–210 V			
Power Volt	not less than 100 V, not more than 420 V			
Break-time at increasing	not more than 0,03 sec			
Break-time at lower:	> 120 V		0,1–10 sec	
	< 120 V		not more than 0,03 sec	
Device weight	0,19 kg $\pm 10$ %			
Overall dimensions (w x h x d)	36 x 85 x 66 mm			
Connection	not more than 16 mm <sup>2</sup>			
IP to GOST 14254	IP20			

## INSTALLATION

**Important.** Before the installation and operation of the device, please read this document to the end. This will help to avoid possible danger, mistakes and misunderstandings.

The appliance is intended for installation inside residences. The risk of moisture or humidity in the installation site should be minimal. The ambient temperature during the installation should be within  $-5...+45$  °C.

The appliance is installed in a special box, which allows to conduct an easy installation and operation. Cabinet should be equipped with standard mounting rail 35 mm width (DIN rail). The appliance takes of two standard module on 18 mm in width. The height of the appliance should be in the range 0,5...1,7 m from the floor.

It's important to set the automatic circuit-breaker (QF) in front of the appliance in order to protect against short circuit and excess capacity in circuit load. The automatic switch off is established in the open-phase fault wire, as it is shown at the Scheme 1. Safety shutdown device is set to protect a person from electric shock leak.

Terminals of the device are designed for wire cross section 2 up to 16 mm<sup>2</sup>. It is advisable to use a soft wire, which is tightened in the terminals with a screwdriver with a tip width of no more than 6 mm with a torque of 2,4 N·m. A screwdriver with a blade more than 6 mm wide can cause mechanical damage to the terminals. Doing so will void your warranty claim.

## CONNECTION SCHEMES

The power supply voltage (100–420 V, 50 Hz) is applied to terminals 1 and 3, with phase (L) connected to terminal 1 and neutral (N) to terminal 3.

The load connection wires are connected to terminal 2 and to the neutral terminal block (not supplied).

### Current and power is measured at the phase input of the device.

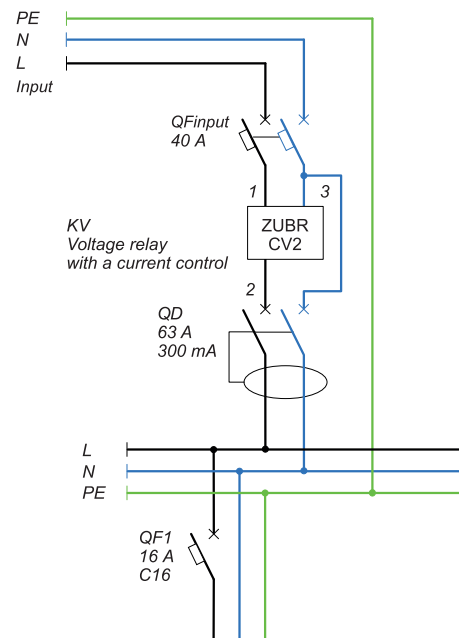

Scheme 1. Variant of the electrical diagram CV2

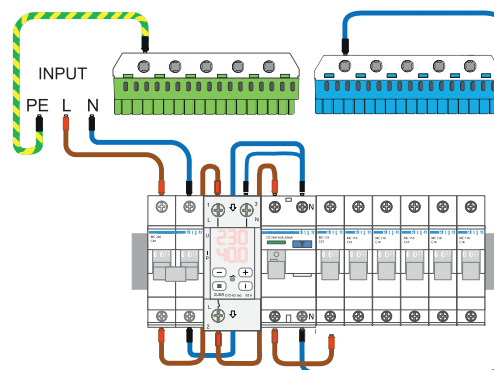

Scheme 2. Variant of the wiring diagram CV2

Table 1. Load shutdown time when the voltage goes beyond the limits

Pro Model (factory setting)	Upper voltage limit	220–280 V	0,03 s
OFF	Lower voltage limit	120–210 V	0,1...10 s
		< 120 V	0,03 s
ON	Upper voltage limit	> 264 V	0,03 s
		220–264 V	0,5 s
	Lower voltage limit	176–210 V	10 s
		154–176 V	0,1...10 s
	< 154 V	0,03 s	

Note: You can activate the Pro Model in the Menu item «Pro». The time, which is marked in blue, can be adjusted in the Menu item «LUT».

## WARRANTY TERMS

The warranty for ZUBR devices is valid for 60 months from the date of sale, provided that the instructions are followed. The warranty period for products without a warranty certificate is counted from the date of production.

If your device is not working properly, we recommend you to read the section «Possible problems» firstly. If you can not find an answer, contact Service Center. In most cases, these actions resolve all issues.

If you continue to have issues with the device, please send it to a Service Center or to the store where you purchased the device. If your device is defective due to our fault, we will repair or replace it under warranty terms within 14 business days.

Please look through the full text of the warranty and the data you need to send to your Service Center on the website <https://www.ds-electronics.company>. If you have a warranty case, please, contact the General distributor in your area.





**SERVICE CENTER CONTACT:**  
+38 (091) 481-91-81  
Viber WhatsApp Telegram  
support@dse.com.ua

## WARRANTY CARD



serial №:	date of sale:
a seller, a seal:	
place of a seal	
an owner contact for a service center:	

## EXPLOITATION

When it is switched on, the device first displays the parameter symbols, then the parameters themselves.



 →  «U» — mains voltage (V)  
«I» — current (A)  
Can be changed to full power «PF» (kVA), in order to change, go to the menu to the item «CPT»

If the voltage is within the permissible limits, the load is switched on after the set delay time and the green indicator lights up.

 →  **When an alarm occurs**, the type of alarm and its value will flash on the screen.



If the voltage deviates from the set limits, the load is disconnected. If the current or power limits are exceeded, the bottom screen will flash and the load will turn off after a delay.

### Setting voltage limits

  (factory setting is 242 V / 198 V)  
To see the upper limit press «+» button, lower limit press «-» button. To change it, use «+» and «-» buttons.

**IMPORTANT.** Use technical documentation for protected equipment during voltage limits settings. All settings are stored in **non-volatile memory**.

### Delay in switching on the load

 →  The settings are described in the Menu. If a voltage surge occurs and the delay time is more than 9 s, the device displays the maximum voltage, then the current voltage with a flashing dot on the right.

 Then the countdown in seconds («t99», «t98»,...) will start until the charging is turned on.

 If the delay time is more than 100 seconds, the screen will display the current voltage with a flashing dot on the right. And when the time is less than 99 seconds, the countdown in seconds will start.

### Reset to factory settings

 Hold the button «≡» for 30 sec until the «dEF» message appears on the screen. When you release the button, the settings are reset and the device reboots.



### Alarm log for 100 values

The voltage relay stores the last 100 values at which the load was switched off in non-volatile memory, where «n 0» is the last trip and «n99» is the oldest. The log records faults in terms of voltage, current, power, or thermal protection operation with temperature recording inside the enclosure.

**To view and navigate the log** press the «i» button. For quick viewing, hold «i». To view in both directions, use the «+» and «-» buttons. First, the device displays the value of the fault, then its number.

 To view the number of entries in the log, hold «i» 3 seconds.

#### Examples of alarms log entries:

 →  High voltage alarm

 →  Power limit exceeded alarm

 →  Current limit exceeded alarm

 →  Internal temperature limit exceeded alarm

 **To reset the log** while viewing it, hold down the «≡» button for 3 seconds until «Err rSt» appears. When you release the buttons, the log is cleared.

### Button lock

Hold down the «+» and «-» for more than 6 sec until the message «Loc»/«unLoc» appears on the screen.













### Menu

All menu settings are described in the table on the right.

Use the «≡» button to select a menu item. Use the «+» or «-» buttons to change the parameters. The first time you press the button, the parameter blinks, the next time you press the button, the parameter is available for change.

The menu is exited in 10 seconds after pressing the buttons or by briefly pressing the «≡» button. When you exit, the device first displays the symbols of the displayed parameters, then the parameters themselves.

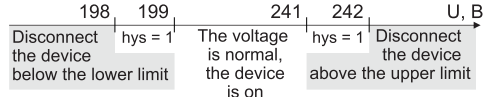
To view the abbreviations of menu items, press the «i» button. For example, «ton» stands for «time on».

Menu	Button «≡»	Screen	Notes
<b>Upper current or power limit</b> factory setting 10 A or 3.0 kVA, for the range of changes, see Technical Data on page 1	press 1 time		The device is set to overcurrent protection from the factory. To change the parameter to be monitored to power, go to the «CPT» section (described below).
<b>Delay in switching on the load</b> factory setting 3 s, a range of change 3–999 s, step 3 s	press 2 times		For protection of refrigeration equipment, if there is a compressor, it is recommended to set a delay of turning on load 120–180 sec.
<b>Delayed load disconnect</b> factory setting 5 s, a range of change 0–240 s, step 1 s	press 3 times		If the current or power is exceeded (select «Cpt» in the next paragraph), the device will count down the delay time and only then turn off the load.
<b>Select the second parameter: current or power</b> factory setting «I <sup>-</sup> », a range of change «PF <sup>-</sup> »	press 4 times		Select the parameter that will be monitored together with the mains voltage monitoring: <ul style="list-style-type: none"> <li>«I<sup>-</sup>» — current,</li> <li>«PF<sup>-</sup>» — full power.</li> </ul>
<b>Maximum number of consecutive triggers for exceeding current, power or voltage</b> factory setting 3, a range of change 1–5 or «oFF»	press 5 times		Protection against frequent actuations. It limits the number of repeated trips beyond the limit if no more than 20 sec have elapsed between turning on the load and activation of the protection. To disable the function, select «oFF».
Advanced settings		Hold «≡» 3 seconds	
<b>Correction voltage on the screen</b> factory setting 0 V, a range of change ±20 V			Use the correction if the voltage readings of the device and your reference device do not match.
<b>Correction current the screen</b> factory setting 0 A, a range of change ±20 % of the measured current	press 1 time		Use the correction if the current readings on the device and your reference device do not match. <i>Example:</i> With a measured current of 10 A, the maximum correction range is ±2 A. With a measured current of less than 1 A, the parameter cannot be changed.
<b>Professional load switch-off time delay model</b> factory setting «oFF»	press 2 times		Useful for low quality AC mains or mains that are overloaded with powerful equipment. Activate it to keep the equipment running when voltage deviations are safe in terms of magnitude and duration Table 1.
<b>Switch-off time in case of voltage failure</b> factory setting 1 s, a range of change 0,1–10 s	press 3 times		It is necessary for more fine-tuning of the protection reaction time to voltage sags. Check Table 1 to see the ranges for which the time can be set.
<b>Delay type of load starting</b> factory setting «tAr»	press 4 times		<ul style="list-style-type: none"> <li>«tAr» time after voltage recovery — the delay is counted from the moment of voltage recovery.</li> <li>«tAo» time after switching off — the delay is counted from the moment the relay is turned off and takes into account response time of the emergency in the total on-delay time.</li> </ul>
<b>Hysteresis</b> factory setting 1 V, a range of change 0–5 V	press 5 times		It is necessary to reduce the number of overcurrent trips when the mains voltage is close to the limit and unstable.
			
<b>Standby brightness</b> actory setting 100 %, a range of change 0–100 %	press 6 times		If the brightness setting is 0, the screen will turn off completely for 30 seconds after the last button press. During an emergency, the screen will be 100 % lit.

continuation of the Table (These settings are available only if «I<sup>---</sup>» is selected in the «CPT» menu item)

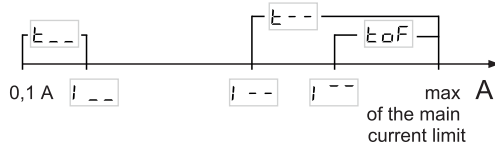
Setting current limits	Hold «≡» 6 seconds	Notes
<b>Additional limit overcurrent trip</b> factory setting «oFF», a range of change 0,1...«I <sup>---</sup> » or between «I <sup>---</sup> » and «I <sup>---</sup> »		For example, to protect an electric motor, it is necessary to limit its operation to maximum power. The additional limit «I <sup>---</sup> » is set no higher than the main limit «I <sup>---</sup> » and no lower than the minimum limit «I <sup>---</sup> », if it is used. See Figure 1 for more details.
		
<p>Figure 1. Relationship between current limits and tripping time beyond such limits</p>		

<b>Delayed shutdown when the additional current limit is exceeded</b> factory setting 10 s, a range of change «toF» + 1 to 240 s	press 1 time 	This is the time that the device will wait before switching off the load if the additional current limit is exceeded. It is available when the additional current limit is enabled.
---	---	---

<b>Minimum limit overcurrent trip</b> factory setting «oFF», a range of change 0,1...«I <sup>---</sup> » or between 0,1 and «I <sup>---</sup> »	press 2 times (1 time, if «I <sup>---</sup> » is off) 	Example, this is the maximum current of an electric motor without load to limit its idling. See Figure 1 for more details.
--	--	--

<b>Delayed shutdown when exceeding the minimum current limit</b> factory setting 6 s, a range of change 0–240 s	press 3 times (2 times, if «I <sup>---</sup> » is off) 	This is the time that the device will wait before switching off the load when the current drops below the minimum limit. Available when the minimum current limit is enabled.
--	---	---

## View all measured parameters

Hold «i» button for 3 seconds. When you release the button, the view is available for 30 seconds. The upper screen displays the symbol of the measured parameter, the lower screen displays its value. Use the «+» and «-» buttons to switch parameters. To quickly exit the view, press «≡».

Options available for viewing:

- COS — capacity factor (cos φ)
- U — voltage
- I — current
- PA — active power
- Pr — reactive power
- PF — full power



## View the firmware version.

Hold «i» for 6 seconds. The version is displayed as a moving line.

## Counter of total protection activations

Hold «i» for 12 sec. It does not reset.

## Temperature of the thermal protection sensor

To view, hold «i» button for 18 seconds.

## Technical Support Chat

If you haven't found the answer, please contact our technical support engineer

@dselectronics\_bot



## POSSIBLE PROBLEMS, CAUSES AND WAYS TO OVERCOME THEM

### At turning on neither the indicator nor the screen don't light up

*Possible cause:* there is no power supply voltage.  
*It is necessary to:* ensure supply voltage presence.

### Screen normal voltage level, load is not turning on

*Possible cause:* the current voltage in the network is close to the established limits and not stable.

*It is necessary to:* check the values of the limits; increase their values so that the protected equipment is tolerated to them. In other cases, please, address to a service centre.

### The load switches off frequently

*Possible causes:* The upper (lower) limit value is too low (too high). Exceeding the set current limits or the selected power.

*Required:* increase the value of the limits so that the protected equipment is tolerant of their values.

### The load is disabled, «oht» flashes on the screen

 The temperature inside the housing has exceeded 80 °C and the internal overheating protection has been activated. «oht» and the temperature of the thermal protection sensor flash 1 time/s on the screen.

*Cause:* internal overheating of the device.

*It is necessary to:* check tension of power wires in the device terminals, make sure that the switching load does not exceed the permissible and that the cross section of the wires is selected correctly.

*Internal overheating protection features:* when the temperature inside the enclosure drops below 60 °C, the device will resume operation. If the protection is triggered more than 5 times per day, the relay will lock and the «oht» inscription will be displayed continuously. Eliminate the overheating problem and wait until the temperature inside the relay drops below 60 °C — the relay will indicate this by displaying a dot at the end of «oht.» Then press any button on the relay to unlock it.

### Every 5 sec the screen displays «Ert»

 *Cause:* open or short circuit of the internal overheating sensor. Control over inner overheating will not be done.

*It is necessary to:* send the device to the Service Center.

### The load is off, on the screen: «rEP Err»

 *Cause:* the maximum number of consecutive trips for exceeding current, power or voltage limits has been exceeded.

*It is necessary to:* unlock the relay by pressing any button, then press «i» to find out the cause of the trip in the Log. Take measures to eliminate the problem, if possible.

Please note that the relay has an automatic unlocking function 1 hour after the «rEP» trip, this measure will ensure partial operation of your equipment until the network problem is resolved.

## SAFETY INSTRUCTIONS

Carefully read and become aware of these instructions.

Connection of the device must be done by a qualified electrician.

Before the installation (dismantling) and connection (disconnection) of the device, turn off voltage supply and also act according to the «Rules of an arrangement of electric installations».

Turning on and off, configure the device should be with dry hands.

Do not connect the device to the network disassembled.

Avoid hitting of water or moisture to the device.

Do not expose the device to extreme temperatures (higher than 40 °C or below -5 °C) and high humidity.

Never clean the device with the use of chemicals such as benzene, solvents.

Do not store the device and do not use it in areas with the dust.

Do not attempt to disassemble and repair the device.

Do not exceed the landmarks value adaptor and power.

To protect against overvoltage caused by lightning discharges, use a lightning protector.

Protect the children from games with the working device, it is dangerous.

## ADDITIONAL INFORMATION

Do not fire and do not throw away the device with the household waste.

After the end of its service life, the product must be disposed of in accordance with applicable law.

Transportation of goods carried in the package ensures the safety of the product.

The device can be transported by any kind of transport (rail, sea, motor, air transportation).

Date of manufacture is on the back side of device.

Application time is unlimited.

The device does not contain harmful substances.

If you have any questions or something is not clear, call the Service centre, the telephone number is listed below.

ZUBR CV2  
d2.2.3G.32.7\_2405



EMC Directive 2014/30/EU  
Low Voltage Directive 2014/35/EU

Manufacturer and vendor: DS ELECTRONICS, LTD  
 Ukraine, 04136, Kyiv region, Kyiv, 1–3 Pivnichno-Syretska str.  
 Sales Department: +38 (091) 481-91-81, support@dse.com.ua  
 www.ds-electronics.com.ua